

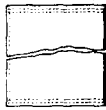





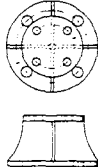
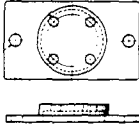

# POWER CONNECTORS

## MISCELLANEOUS SECTION Hb

 Type FP Page Hb-1	 Type FA Page Hb-1	 Type FL Page Hb-1	 Type FX Page Hb-1
 Type SM Page Hb-2	 Type SME Page Hb-2	 Type SMH Page Hb-2	 Type SLH Page Hb-4
 Type DSL Page Hb-4	 Type C Page Hb-5	 Types CBO and CBI Page Hb-5	 Type CL Page Hb-6
 Special Laminated Connectors Page Hb-6			

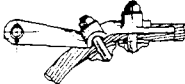
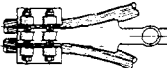
Hb-Miscellaneous

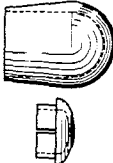
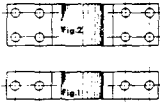
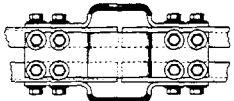
**ROYAL SWITCHGEAR MANUFACTURING CO.**

3995 Pine Lane SE • Bessemer, AL 35023 • (205) 426-4090 • FAX (205) 426-4095

# POWER CONNECTORS **Hb-1**

## ADAPTERS OR SPACERS

### TYPE FP

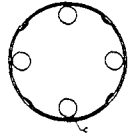

FOR 3" OR 5" BOLT CIRCLE INSULATORS

Catalog No.	Bolt Circle	Dimension in Inches		
		A	B	C
9804	3 TO 3	SPECIFY	3 1/2	9/16
9805	5 TO 5	SPECIFY	6	11/16

Example for Ordering: - #9804 Royal Type FP Adapters 3" Bolt Circle 3-1/2" high.

Type FP Adapters are made of heavy steel pipe. Plate inserts, drilled either for 3" or 5" bolt circle, are welded in the pipe section and the complete unit hot dip galvanized.

Adapters accurately machined to any height plus or minus 1/32" can be furnished.

### TYPE FA

FOR 3" OR 5" BOLT CIRCLE INSULATORS

Catalog No.	Bolt Circle	Dimension in Inches			
		A	B	C	D
15177	3 TO 3	SPECIFY	1 1/4	4 1/4	9/16
15310	5 TO 5	SPECIFY	3	6 1/4	11/16

Example for Ordering: - #15310 Royal Type FA Adapters 5" Bolt Circle 7" high.

Type FA Adapters are made of extra heavy steel pipe, jig welded to 1/2" thick mounting plates.

Extremely accurate overall heights are maintained.

Short mounting bolts or cap screws are used.

### TYPE FL

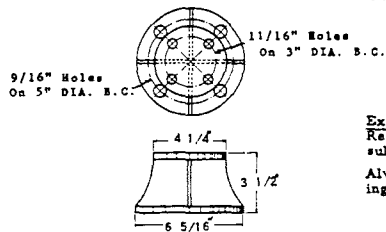

Catalog No.
6157

Example for Ordering: - #6157 Royal Type FL Reducing Adapters 3" to 5" Bolt Circle. Insulators pin mounted.

Always specify whether for cap or pin mounting.

### TYPE FX

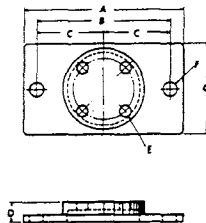

3" BOLT CIRCLE - TWO HOLE MOUNTING

Catalog No.	Dimensions in Inches						
	A	B	C	D	E	F	G
9756	7 3/4	6 1/2	3 1/2	1	9/16	9/16	4 1/2

Example for ordering: #9756 Royal Type FX Base adapter.

The Type FX is useful where the structure will not permit mounting the insulator direct. This adapter is steel hot dipped galvanized.

Hb-Miscellaneous

## ROYAL SWITCHGEAR MANUFACTURING CO.

3995 Pine Lane SE • Bessemer, AL 35023 • (205) 426-4090 • FAX (205) 426-4095

# Hb-2 POWER CONNECTORS

## SPRING STRAIN BUS ASSEMBLIES

### TYPE SM

Catalog No.	Compression Strength	Dimensions in Inches				
		A	B	C	D	E
12640	500 LBS.	6	7/8	5.2	8	3
9818	1000 LBS.	6	7/8	5.0	8	3
9819	2000 LBS.	6	7/8	5.2	8	3
15167	4900 LBS.	6	1 1/2	5.5	13 3/16	5

**Example for Ordering:** - #9818 Royal Type SM Spring Strain Bus Assembly 1000# Rating.

Spring Strain assemblies are widely used to maintain tension in strain busses and at other conductor dead ends.

The Type SM is open design.

The Spring is heavily electro-galvanized.

When installed, face "F" bears against structure.

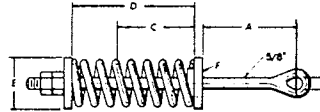

### TYPE SME

Catalog No.	Compression Strength	Dimensions in Inches			
		A-Min.	A-Max.	B	C
12641	500 LBS.	20-5/8	23-1/2	10-7/16	4-1/2
12642	1000 LBS.	20-5/8	23-1/2	10-7/16	4-1/2
12643	2000 LBS.	20-5/8	24-1/2	10-7/16	4-1/2

**Example for Ordering:** - #12643 Royal Type SME Spring Strain Bus Assembly 2000# Rating.

The Type SME is a light duty universal design with housed spring. Tension is developed either by bearing on structure at face "D" or as a pure tension device by attaching eye nut to structure and insulators and conductor to eyebolt. Housing is galvanized steel pipe.

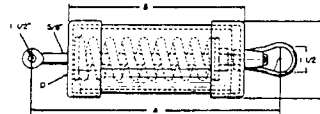

### TYPE SMH

Catalog No.	Compression Strength	Dimensions in Inches			
		A-Min.	A-Max.	B	C
12644	2100 LBS.	12-3/4	15	10-1/2	7-3/4
12645	2610 LBS.	14-1/2	18-1/2	12-1/4	7-3/4
12646	4900 LBS.	20-1/8	25-3/8	17-7/8	7-3/4

**Example for Ordering:** - #12646 Royal Type SMH Spring Strain Bus Assembly 4900# Rating.

Type SMH is a heavy duty design where it is desired to maintain uniform sag in conductors or strain busses under high stringing tensions. Housing is extra heavy galvanized steel pipe. End caps are malleable iron hot dip galvanized. Eye bolt is specially machined and hot dip galvanized.

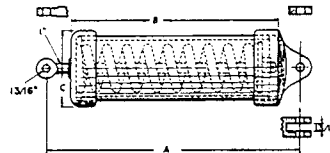

**ROYAL SWITCHGEAR MANUFACTURING CO.**

3995 Pine Lane SE • Bessemer, AL 35023 • (205) 426-4090 • FAX (205) 426-4095

# POWER CONNECTORS **Hb-3**

## COMPRESSION CURVES FOR SPRING STRAIN ASSEMBLIES

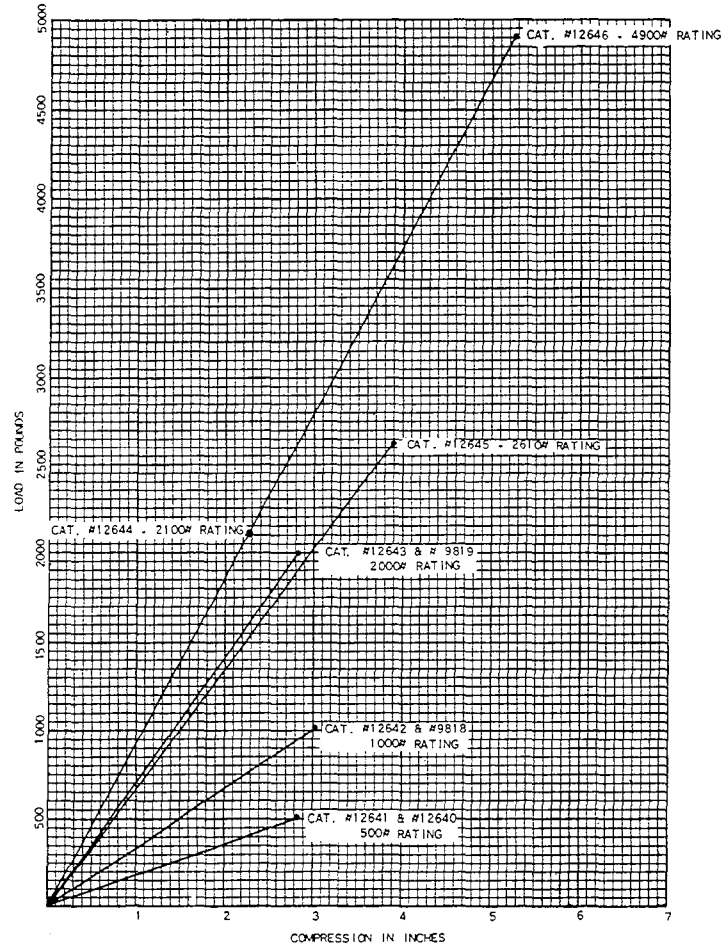

Hb-Miscellaneous

**ROYAL SWITCHGEAR MANUFACTURING CO.**

3995 Pine Lane SE • Bessemer, AL 35023 • (205) 426-4090 • FAX (205) 426-4095

# Hb-4 POWER CONNECTORS

## CABLE DEAD-END CLAMPS

### TYPE SLH

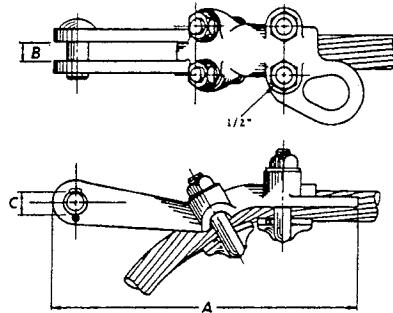

Catalog No.	Cable Range		Dimensions in Inches			Bolt Size
	Min.	Max.	A	B	C	
14854	1/0 STR	500 MCM	7 3/16	11/16	5/8	1/2
14855	500 MCM	1000 MCM	7 1/2	3/4	5/8	1/2

Example for Ordering: - #14854 Royal Type SLH Dead End Clamp 1/0 - 500 MCM Cable.

Type SLH is cast bronze with galvanized steel "U" bolts and rivets. Individual keepers assembled captive on "U" bolts provide highest contact pressure. Pulling eye makes installation easy. Primarily designed for use with strain bus. Slip strength 6000 lbs.

### TYPE DSL

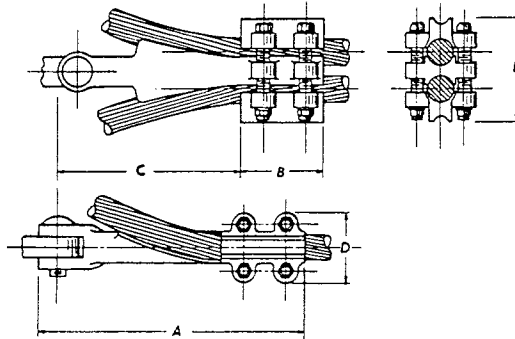

Catalog No.	Cable Range				Dimensions in Inches				
	Min.	Max.	Min.	Max.	A	B	C	D	E
12630	1/0 STR.	4/0 STR.	250 MCM	500 MCM	8 1/2	2 1/2	6	2 1/4	4
12631	300 MCM	500 MCM	600 MCM	1000 MCM	9 1/4	3 1/4	6	2 7/8	4 3/4

Example for ordering: - #12631 Royal Type DSL Dead End Connectors 300 MCM - 1000 MCM cable.

The design of Type DSL was suggested by utility engineers as a device for supporting double strain busses and service drops; for a combination dead end strains and for closing the delta on transformers. The Type DSL is full bronze.

**ROYAL SWITCHGEAR MANUFACTURING CO.**

3995 Pine Lane SE • Bessemer, AL 35023 • (205) 426-4090 • FAX (205) 426-4095

# POWER CONNECTORS Hb-5

## FLEXIBLE CONNECTIONS TYPE C

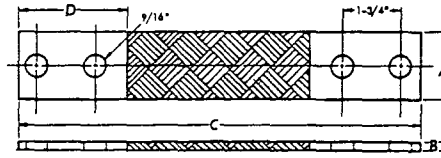

Catalog No.	Ampere Rating	Number and Size of Braid	Dimensions in Inches			
			A	B	C	D
7312	200	1 - 76800 Ohm	1	1/8	12	3
7313	375	2 - 76800 Ohm	1	1/4	12	3
15841	400	3 - 76800 Ohm	1	1/4	12	3
7314	450	1 - 302400 Ohm	1 1/2	5/16	12	3
7315	550	1 - 302400 Ohm	1 1/2	3/8	12	3
15842	650	2 - 76800 Ohm	1 1/2	13/32	12	3
15843	750	3 - 76800 Ohm	1 1/2	7/16	12	3
7317	800	2 - 302400 Ohm	1 1/2	1/2	12	3
15844	900	2 - 76800 Ohm	1 1/2	5/8	12	3
15845*	1000	3 - 302400 Ohm	1 1/2	13/16	12	3
15846*	1200	4 - 302400 Ohm	1 1/2	1	12	3

\* Catalog #15845 consists of (1) #7314 and (1) #7317.

\* Catalog #15846 consists of (2) #7317.

Example for Ordering: — #7315 Royal Type C Flexible Braid Connectors "C" Dimension 18".

Type C Flexible Connectors will carry rated capacity indoors. Wire is tinned before stranding. Ferrules are completely tinplated to provide low contact resistance. Standard length is 12" overall. Specify length required if longer or shorter than standard. Ferrules can be furnished to any length specified.

## FLEXIBLE LAMINATED SHUNTS TYPE CL



Catalog No.	Amps Rating	Flg. No.	Width	Dimensions in inches				
				A	B	C	D	E
9637	375	1	1 1/2	5/8	3 1/4	1 3/4	1 1/2	9
9638	500	1	2	5/8	3 3/4	1 3/4	1 1/2	8 1/2
9639	750	2	3	5/8	4 1/2	1 3/4	1 3/4	9 1/4
9640	1000	2	4	5/8	6	1 3/4	2	10 3/4

Example for ordering: — #9638 Royal Type CL flexible laminated connectors.

Unless otherwise specified Type CL is made of copper strips #24 B & S gauge (.020") thick. Strips are tinned and sweated together and drilled after sweating. Care is taken so that solder does not extend beyond line of bend. Connectors will be furnished undrilled or with special drilling as specified.

## CORONA END BELLS

### TYPE CBI

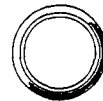

### TYPE CBO

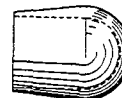

IPS Size	Cat. No. Type CBI	Cat. No. Type CBO
1/2	7144	7154
3/4	7145	7155
1	7146	7156
1 1/4	7147	7283
1 1/2	7148	7284
2	7149	7295
2 1/2	7150	7296
3	7151	7297
3 1/2	7152	7298
4	7153	7299

For Copper or Aluminum Tube

Accurately Machined for Shrink fit.

Example for ordering: — #7149 Royal Type CBI Corona End Bells 2" IPS.

Hb-Miscellaneous

## ROYAL SWITCHGEAR MANUFACTURING CO.

3995 Pine Lane SE • Bessemer, AL 35023 • (205) 426-4090 • FAX (205) 426-4095

## FLEXIBLE LAMINATED CONNECTORS

Types of special preformed laminated connectors. These were supplied for circuit breaker to bus connections. All types of preformed laminated connectors can be supplied to meet specifications.

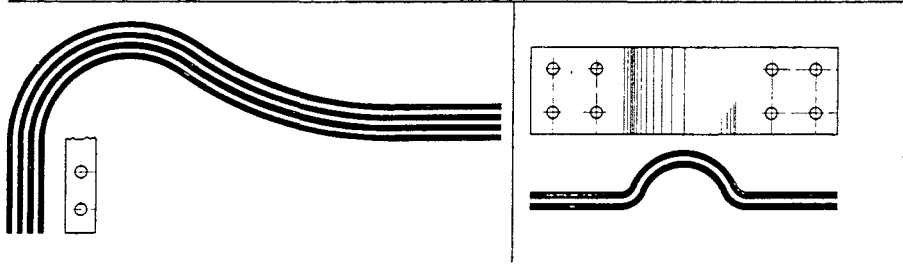
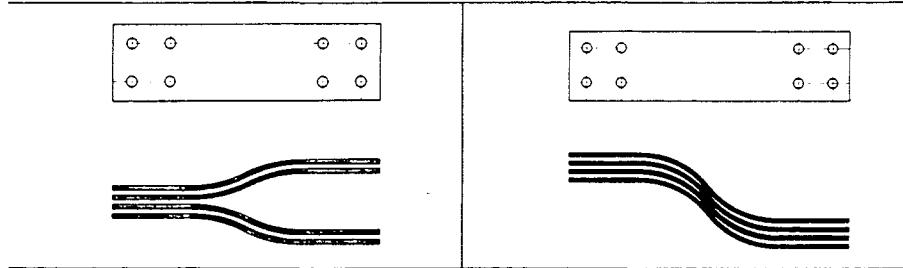

Assembly of expansion joint for three inch hollow square channel bus.

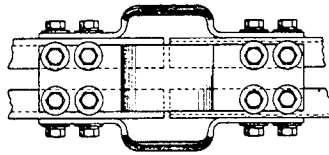

Assembly of expansion joint between three inch hollow square channel bus and 3000 ampere disconnecting switch.

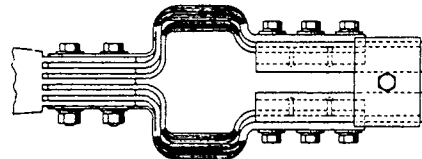

Flexible connector with special tinned length and drilling.

